



TEC 2500

Water bath-Slide drier

Operation Manual

AMOS SCIENTIFIC PTY.LTD. ABN37 159 778 140

www.amos-scientific.com

Fore Word

Thank you for purchasing our TEC 2500 Water Bath-Slide Drier. Presented in this 《Operation Manual》 are the functions and operation methods of the TEC2500 Water Bath-Slide Dryer and the matters needing attention concerning safety. Please carefully read this manual before use so that you can understand its performance better and make full use of the functions. If you have any questions, contact us and we will provide best service for you at any time.

Please keep this 《Operation Manual》 appropriately for later consultation

Contents

1. Safety Instruction.....	1
1.1 Safety Matters.....	1
1.2 Conditions of installation.....	1
1.3 Delivery Inspection.....	1
2. Performance Features & Range of Application.....	1
3. Main structure.....	2
4. Technical Parameters	3
5. Operation	3
5.1 Keypad Description & Function.....	3
5.2 Instruction.....	4
6. Layout Of Components & Electric Wiring Diagram.....	5
7. Trouble Shooting	6
8. Layout Of Components In Pcb Circuit Board.....	7
9. Schematic Diagram of Electric Equipment.....	7
10. Wiring Diagram	8



Safety Instruction

1.1 Safety Matters

- Please read these concise rules. Any violation against them will affect normal use of equipment or cause damage to equipment or danger.



Please use 220VAC $\pm 10\%$ at 50HZ or 110V $\pm 10\%$, 60Hz AC.



Input power supply must be of good earth connection .



Keep away from flammables and explosives.



Don't open equipment without authorization to avoid high voltage shock.



Only professional maintenance personnel is allowed to repair equipment.



Use fuses with correct capacity



Ensure power socket and circuit be able to bear 2 times of rated current at least.



Keep away from from any interference source.



Caution: Hot.

- **Electrical Protection Ratings: I class, B type**
- **Shell protection grade: IP53**
- **Harmful liquid Leak-in proof degree: Normal (enclosed equipment without liquid leak-in proof)**
- **Working system: Continuous operation**

1.2 Conditions of installation

- Ensure more than 20cm of space around the equipment for heat dissipation.
- No water drop, steam, dust including oily dust and floating dust.
- No erosive, flammable and explosive gas and liquid.
- Solid and non-vibration.
- No interference from other electromagnetic signals.
- Operating ambient temperature from 5°C to 40°C, relative humidity under 90%

1.3 Delivery Inspection

Although the product has already been inspected before leaving the factory, the following inspection is necessary at delivery because the product may be damaged and accessories get missing caused by careless handling during transportation.



Ensure that the product, operation manual, and accessories are the same as those you ordered. Check for any damage, aging, or missing parts during transportation.

Operation

The TEC2500 Water Bath-Slide Drier has the characteristics of digitalization, precise temperature control, and easy operation, making it more reliable. This drier can be widely used in various industries.



4. Technical Parameters

- temperature range
Bath tank: room temperature~90°C, the most favorable temperature is in 45°C
Oven: room temperature~90°C, the most favorable temperature is in 70°C
Warmer: room temperature~90°C, the most favorable temperature is in 70°C
- input voltage:220v±10% at 50Hz or 110v±10% at 60Hz
- Fuse:220V/5A or 110V/8A
- rated power::600W
- outside dimensions(mm):550×340×140
- weight: 9Kg

5. Operation

5.1 Explanation Of Functional Keys

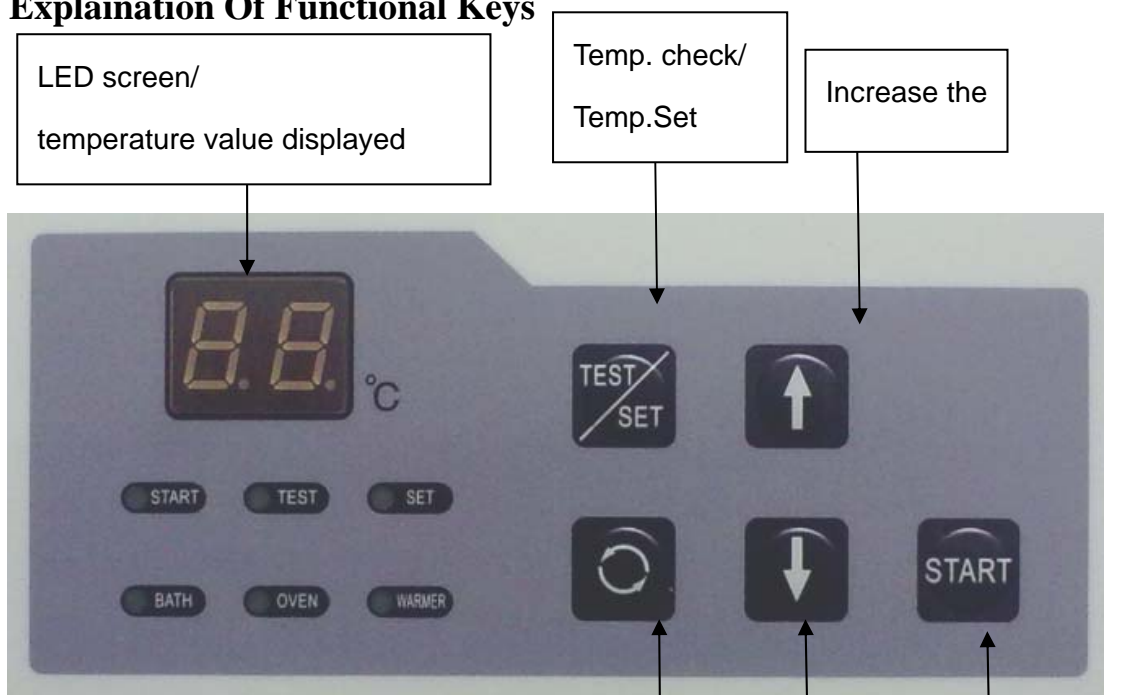

- START** its indicator light that means machine is on heating.
- TEST** its indicator light that means the screen displayed the test temperature.
- SET** its indicator light that means the machine is on set temperature mode.
- BATH** its indicator light that means the machine is on water bath mode.
- OVEN** its indicator light that means the machine is on oven mode.
- WARMER** its indicator light that means the machine is on drier mode.

Cycle button
Press this key to select one of three functions:
bath,oven, warmer.

● Key and function

Start heating switch;

Test/Set for temperature measurement or temperature setting;

 for function change-over. Press this key to select one of the three

functions of oven, bath and warmer;

 Press this key to increase the temperature;

 Press this key to decrease the temperature

● Indicator lamp and function

 °C This lamp indicates the temperature;

Start When this lamp lights ,it means that the apparatus is in heating state;

Test When this lamp lights, the value shown by  °C is the measured temperature;

set When this lamp lights, the value shown by  °C is the set temperature.

At the moment, it is also possible to set the temperature again;

Bath When this lamp lights, it means that the apparatus is in bath state;



Oven When this lamp lights, it means that the apparatus is in oven state;



Warmer When this lamp lights, It means that the apparatus is in warm state;

5.2 Instruction

1. Take out the bath tank and fill it with proper amount of water (The water level in the tank should be between one third and two thirds of the depth of the tank).Then put the tank back. Please don't fiddle with the digital sensor under the tank to avoid affecting temperature control.

2. Connect the equipment to power supply and turn on the switch at the rear of the equipment.

3. Press the key  until the indicator lamp **Bath** lights. Then press **Test/set** until the lamp **set** light. Now press to set ,  the required temperature in the bath tank.

4. Press the key  till the lamp **Oven** lights. Then press **Test/set** until the lamp **set** light. Now press to set ,  the required temperature in the oven.

5. Repeat the above process to set the temperature in the warmer.

6. After setting the temperature in the bath tank, oven and warmer, press **Start** till the lamp **start** lights. At the moment, heating begins. When the set temperature is reached, press **Start** again to heating stops and the set temperature is kept constant.

Note: Normally, heating should begin half an hour before operation.

◆ How to check the temperature to see if it reaches the set value

After the equipment is heated for a period of time, press the key **Test/set** to check the temperature in the bath tank, oven or warmer as follows:

To check whether the temperature in the bath tank, for example, reaches the set value, press the key  till the lamp **Bath** lights, and then press the key **Test/set** till the indicator **Test** lights. The value shown by °C is the current temperature in the bath tank. The current temperature in the oven and warmer is also checked in the same way.

After using of the equipment, press the key **start** till the indicator **start** goes out and then turn off the power switch at the rear of the equipment.

6. Cleaning & Maintenance

- The input power supply must have good earth connection
- The bottom of water bath box must keep dry for fear of creep aging or bobbling heating up piece. Keep the equipment clean for fear of influencing the control of temperature.
- Take care that the outside heating up piece hurt you.
- Install fuse as figure(1) shown then put it into the installation part as figure(2)shown. At last put the whole installation into the receptacula as figure(3)shown.
- Before replacing the fuse must turn off the power switch and disconnect the power.

Specification of fuse: 5A (220V) ,8A(110V).

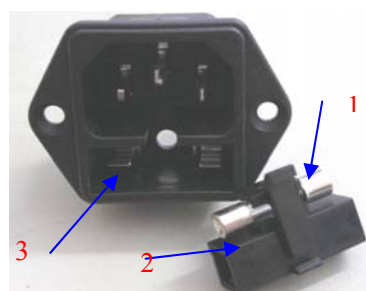

7. Trouble Shooting

Symptom		Cause	Judgment	Remedy
Display on the operation panel does not work		Poor connection of power supply	Connection again	Correct it
		Switch at the rear of the equipment not on	Turn on	Turn it on
		Fuse blow	Take out the fuse to check its internal resistance by multimeter, if the value is infinite, the fuse is broken	Replace a new one
Temperature in the bath tank is not accurate		dirty substance at the bottom	Clean the bottom	Clean the bottom and put the right position
Buzzer sounds	LCD Shows E1	Sensor in bath tank is damaged	Connect a new sensor to right terminal to start machine, if all be okay, it means the sensor is broken	Replace a new sensor
	LCD Shows E2	Sensor in oven is damaged		
	LCD Shows E3	Sensor in warmer is damaged		
	LCD Shows E4	Bath tank is overheated (relay in bath tank is damaged)	Check the relay	Replace a new relay
	LCD Shows E5	Oven is overheated (relay in drying oven is damaged)		
	LCD Shows E6	Warmer is overheated (relay in baking trough is damaged)		
No heating		Heating film damaged	Check the heating film maybe broken because the overheated	Replace a new heating film
		Fuse blow	Take out the fuse to check its internal resistance by multimeter, if the value is infinite, the fuse is broken	Replace a new fuse

If other troubles occur or the above troubles can not be eliminated, please contact us.

8. Layout Of Components In Pcb Circuit Board

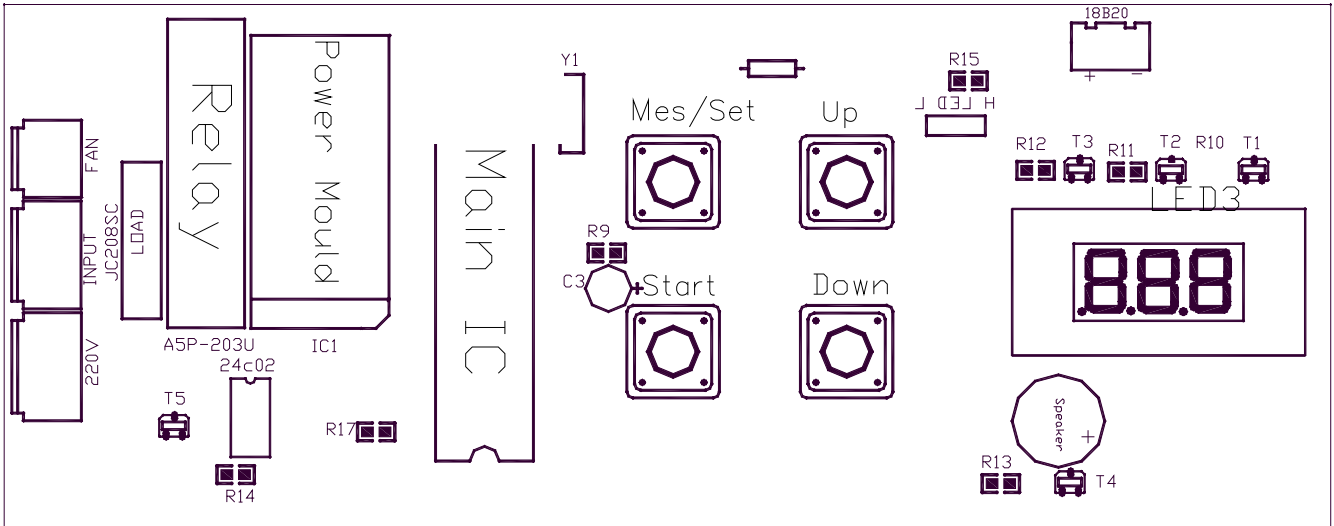

9. Schematic Diagram of Electric Equipment

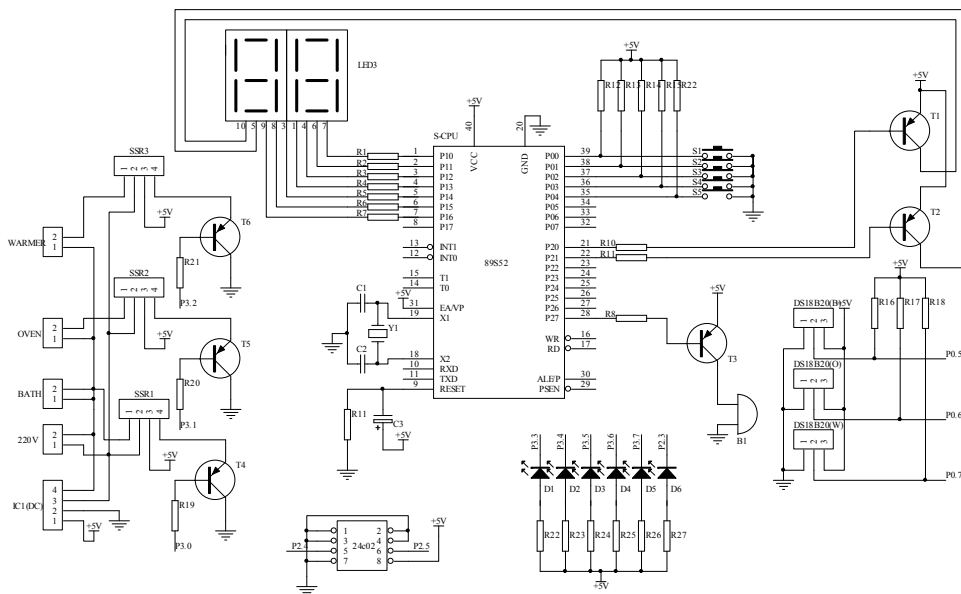

10. Wiring Diagram

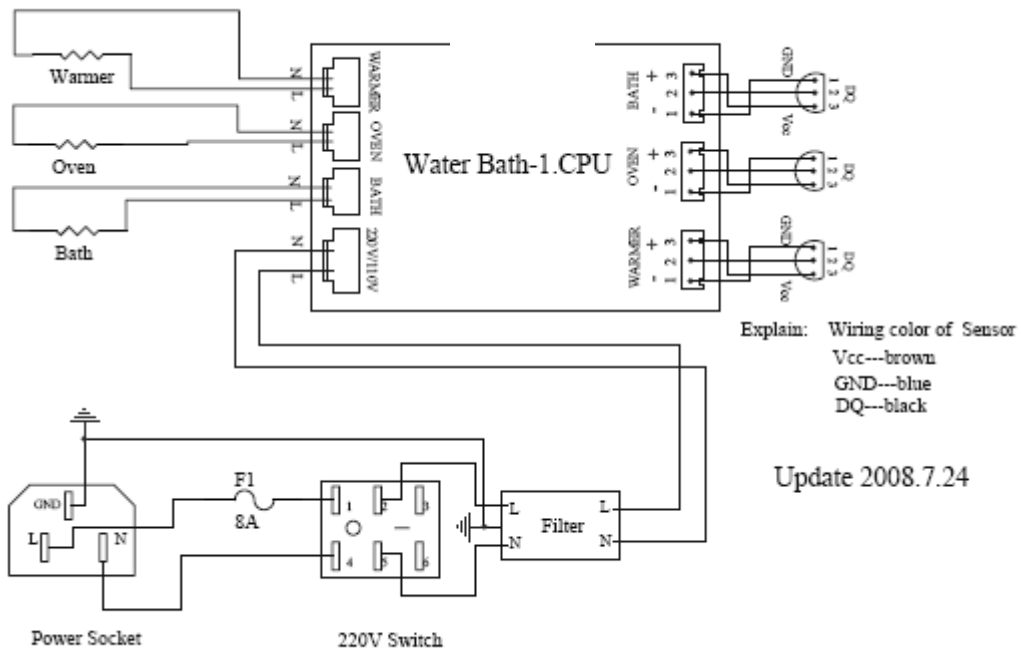

Standard Accessories List

No	Accessory Name	Qty	Notes
1	Water bath-slide drier	1 unit	
2	Power Cord	1pc	
3	Fuse	2pcs	
4	Operation Manual	1pc	

Published by:

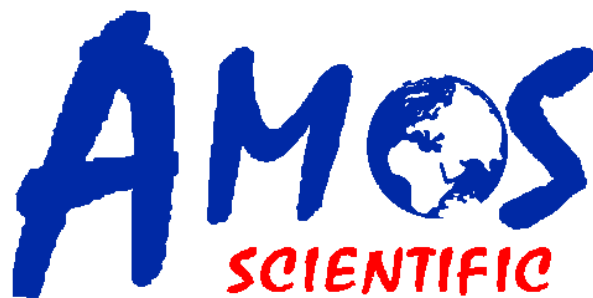

AMOS SCIENTIFIC PTY.LTD

7 Gabrielle Court, Bayswater North VIC 3153 Melbourne , Australia

Tel: +61-410190188 Fax: +61-410190188

ABN 37 159 778 140

www.amos-scientific.com